

# OFFICITY<sup>®</sup>

business space

## ARMADI



# Descrizione tecnica

## ARCHIVIAZIONE

### Scocche in melaminico

Le strutture Sp. 18 mm, gli schienali Sp. 8 mm ed i ripiani Sp. 25 mm sono realizzati in conglomerato ligneo rivestito con melaminico antiriflesso, antigraffio e lavabile. Gli schienali sono a vista. I ripiani sono disponibili (optional) anche in lamiera di acciaio verniciata a polveri epossidiche. Tutti i ripiani sono dotati di particolari reggipiani a scomparsa che evitano la flessione dei fianchi sotto carico e che consentono lo spostamento in altezza ogni 32 mm. La struttura è dotata di n. 5 piedini livellatori in ABS. I top e i fianchi di finitura (optional) sono in conglomerato ligneo Sp. 30 o 38 mm rivestito con melaminico antiriflesso, antigraffio e lavabile, e sono bordati 3 lati con ABS antiurto in tinta Sp. 2 mm.

### Scocche in metallo

Realizzate in lamiera piegata decapata sp. 7/10 mm e verniciate con polveri epossidiche. Assemblate tramite giunzioni a coppia conica, in acciaio, con pignone ad angolo di ingresso agevolato di 12°, su lato interno. Tappi copertura fori realizzati in iniezione di ABS, fissati tramite innesto a pressione. Paracolpi per ante realizzati in iniezione di gomma, fissati alla scocca tramite innesto a pressione. Piedini scocca D.50 realizzati in iniezione di nylon nero, dotati di piedino di regolazione con escursione da 0 a 15 mm, realizzati in acciaio tornito e base antigraffio stampata in nylon nero.

### Schiene in metallo (per strutture in metallo)

Realizzate in lamiera piegata decapata sp. 6/10 mm e verniciate con polveri epossidiche. Assemblate tramite giunzioni a coppia conica, in acciaio, con pignone ad angolo di ingresso agevolato di 12°, su lato interno.

**OPZIONE RIPIANO METALLICO PER ARMADIO L 43: + 8 € per ogni ripiano**

**OPZIONE RIPIANO METALLICO PER ARMADIO L 86: + 14 € per ogni ripiano**

### Ante

- **melaminico** (per scocche in melaminico e metallo): conglomerato ligneo melaminico antiriflesso, antigraffio e lavabile, bordato sui 4 lati in ABS antiurto in tinta sp. 1,5 mm.

- **laccato** (per strutture in melaminico e metallo) realizzate in pannelli in conglomerato ligneo Sp. 18 mm, rivestiti in melaminico, bordati 4 lati in ABS antiurto Sp. 1,5 mm, il tutto verniciato laccato opaco in vari colori.

- **cuoietto**: in pannello di conglomerato ligneo spessore 18 mm rivestito con carta melaminica e bordato con carta. I lati esterno ed interno e i bordi, del pannello, sono rivestiti in cuoio rigenerato sp. 13/10 di mm, con cuciture in tinta, decorative, lungo il perimetro. Il cuoio del lato esterno è un unico pezzo risvoltato sui quattro lati, per coprire lo spessore dell'ante e poi risvoltato sul lato interno (per qualche centimetro) per non vedere giunzioni sui lati esterni, in vista. La parte centrale del lato interno è rivestito con un secondo pezzo di cuoio.

- **impiallacciato**: in pannello di conglomerato ligneo spessore 18 mm, impiallacciato legno spessore 6/10 di mm, con bordi perimetrali in legno spessore 1 mm, spigoli raggiati 0,5 mm e verniciatura trasparente opaco a poro semiaperto.

- **vetro con telaio in alluminio** (per scocche melaminico): vetro temprato Sp. 4 mm verniciato effetto satinato con telaio in alluminio anodizzato. Disponibile, come optional, un sistema di chiusura ammortizzata "Soft".

- **vetro senza telaio** (per scocche melaminico): vetro temprato Sp. 4 mm colore grigio Europa, con bordi e spigoli arrotondati.

Le ante sono complete di cerniere con apertura a 95°, realizzate in lamiera stampata e trattata contro la corrosione. Le cerniere delle ante in conglomerato consentono la regolazione dell'ante in tre direzioni.

- **metallo** (per scocche metallo): disponibili per strutture in metallo, realizzate in lamiera piegata decapata verniciata con polveri epossidiche. Serratura e chiusura "Soft" di serie.

### Zoccoli

Gli zoccoli sono realizzati in ABS stampato, resistente a lavaggio e urti.

### Top e fianchi di finitura (per strutture in melaminico)

I top e i fianchi di finitura, sono disponibili in 3 versioni:

- sp. 18 mm, realizzati in conglomerato ligneo melaminico antiriflesso, antigraffio e lavabile, bordati sui 4 lati con ABS antiurto in tinta sp. 2 mm

- sp. 18 mm, realizzati in pannelli in conglomerato ligneo, rivestiti in melaminico, bordati 4 lati in ABS antiurto Sp. 2 mm, verniciato laccato opaco.

- sp. 30 mm, realizzati in conglomerato ligneo melaminico antiriflesso, antigraffio e lavabile, bordati sui 4 lati con ABS antiurto in tinta sp. 2 mm

- sp. 30 mm, realizzati in conglomerato ligneo spessore 30 mm rivestito con carta melaminica e bordato con carta e bordo ABS spessore 2 mm. I lati e i bordi esterni in vista, sono rivestiti in cuoio rigenerato sp. 13/10 di mm, con cuciture in tinta, decorative, lungo il perimetro e in corrispondenza delle giunzioni.

Il cuoio del lato esterno è un unico pezzo risvoltato sui quattro lati, per coprire lo spessore del pannello e poi risvoltato sul lato interno (per qualche centimetro) per non vedere giunzioni sui lati esterni, in vista; per tale ragione il top in lunghezza 129 cm e 215 cm NON è fattibile;

**Top e Fianchi di finitura impiallacciati legno** : in pannello di conglomerato ligneo spessore 28 mm, impiallacciato legno spessore 6/10 di mm, con bordi perimetrali in legno spessore 1 mm e 6/10 di mm, spigoli raggiati 0,5 mm e verniciatura trasparente opaco a poro semiaperto.

## Maniglie per ante melaminico, laccato, cuoietto e impiallacciate

### Maniglie in ABS di serie

Look



\_finitura alluminio (J)  
\_finitura bianco (JB)

### Maniglie in metallo opzionali +€ 5 cadauna

Pop



\_finitura alluminio (P)  
\_finitura cromata (K)

Zen



\_finitura alluminio (Z)  
\_finitura bianco (A)  
\_finitura grigio Ombra (Q)  
\_finitura cromata (Y)

# Finiture

## Scocca

ME - Melaminico

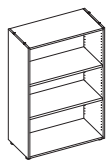

AA - ARGENTO



BA - BIANCO



TA - TESSUTO ANTRACITE



## Ante e frontali cassetti

ME - Melaminico

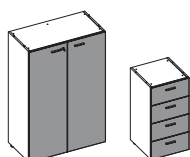

OL - OLMO



WE - WENGÉ

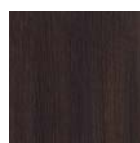

BA - BIANCO



GR - GRIGIO



RR - ROVERE

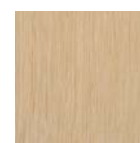

NO - NOCE CANALETTO



LE - Legno Impiallacciato

OG - OLMO GRIGIO



NA - NOCE AMERICANO



EB - EBANO RIGATO



LA - Laccato opaco\*

\*TEMPI DI CONSEGNA: 5 SETTIMANE; FINITURE LACCATE PROPOSTE; TUTTE LE FINITURE DELLA SCALA RAL SONO DISPONIBILI

LT - GRIGIO BEIGE  
RAL7006



LH - ROSSO FUOCO  
RAL 3000



LL - BIANCO GRIGIO  
RAL9002

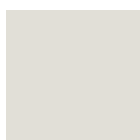

LX - GIALLO ORO  
RAL1004



LS - GRIGIO SETA  
RAL7044



LM - GRIGIO  
MARRONE RAL8019



LA - ARANCIONE  
RAL2000



LR - ROSSO  
PORPORA RAL3004



LB - BIANCO  
RAL9003

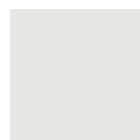

LF - TELE GRIGIO  
RAL7047

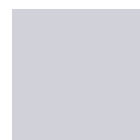

LE - BEIGE  
RAL1019



LC - BLU COLOMBA  
RAL5014



LO - GRIGIO  
OMBRA RAL7022



LY - BLU  
VIOLACEO RAL5000



LG - GRIGIO  
RAL7004



LZ - BLU ZAFFIRO  
RAL5003



LV - VERDE  
RAL6013



LN - NERO  
TRAFFICO RAL9017



CU - Cuoietto\*

\*TEMPI DI CONSEGNA: 5 SETTIMANE

CRS - ROSSO



CMA - MARRONE



CGA - ANTRACITE



CNE - NERO



## Piedini a sezione tonda

I - BIANCO RAL 9016  
O - BIANCO OPACO RAL 9010    A - ARGENTO RAL 9006

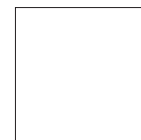
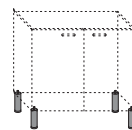

## Piedini a sezione rettangolare

R - GRIGIO OMBRA RAL 7022    O - BIANCO OPACO RAL 9010    C - CROMO

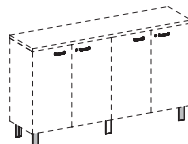

## Zoccoli

R - GRIGIO OMBRA RAL 7022    I - BIANCO RAL9016    A - ARGENTO RAL 9006



## Profilo

R - GRIGIO OMBRA RAL 7022    I - BIANCO RAL 9016    A - ARGENTO RAL 9006    L - BRILLANTATO CROMO

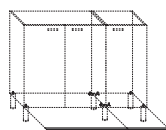

## Ante vetro con telaio alluminio

Vetro

Telaio

V3 - ACIDATO

L - BRILLANTATO CROMO    A - ARGENTO RAL 9006

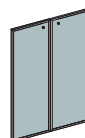

## Ante vetro senza telaio

GE - VETRO FUMÈ

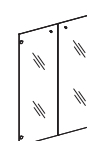

## Top e fianchi di finitura sp. 30mm

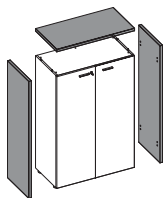

ME - Melaminico

GR - GRIGIO NO - NOCE CANALETTO BA - BIANCO RR - ROVERE OL - OLMO

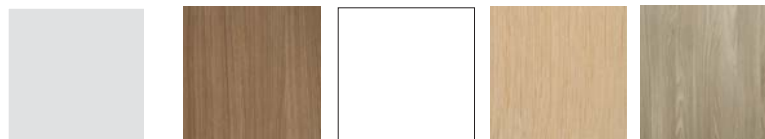

LE - Legno Impiallacciato

OG - OLMO GRIGIO NA - NOCE AMERICANO EB - EBANO RIGATO

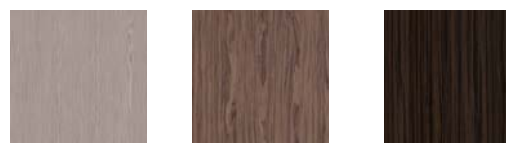

CU - Cuoietto\*

\*TEMPI DI CONSEGNA: 5 SETTIMANE

CRS - ROSSO CMA - MARRONE CGA - ANTRACITE CNE - NERO



## Top e fianchi di finitura sp. 18mm

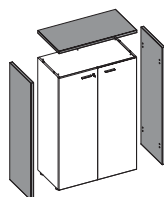

ME - Melaminico

GR - GRIGIO RR - ROVERE OL - OLMO BA - BIANCO NO - NOCE CANALETTO WE - WENGÈ



L - Laccato

TEMPI DI CONSEGNA: 5 SETTIMANE; FINITURE LACCATE PROPOSTE; TUTTE LE FINITURE DELLA SCALA RAL SONO DISPONIBILI

LT - GRIGIO BEIGE RAL7006 LL - BIANCO GRIGIO RAL9002 LS - GRIGIO SETA RAL7044 LA - ARANCIONE RAL2000 LB - BIANCO RAL9003 LE - BEIGE RAL1019 LO - GRIGIO OMBRA RAL7022 LG - GRIGIO RAL7004 LV - VERDE RAL6013



\*\*LH - ROSSO FUOCO RAL 3000 LX - GIALLO ORO RAL1004 LM - GRIGIO MARRONE RAL8019 LR - ROSSO PORPORA RAL3004 LF - TELE GRIGIO RAL7047 LC - BLU COLOMBA RAL5014 LY - BLU VIOLACEO RAL5000 LZ - BLU ZAFFIRO RAL5003 LN - NERO TRAFFICO RAL9017

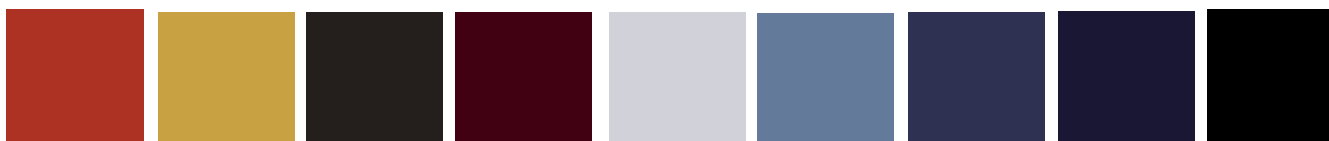

## Schema dimensionale contenitori in metallo

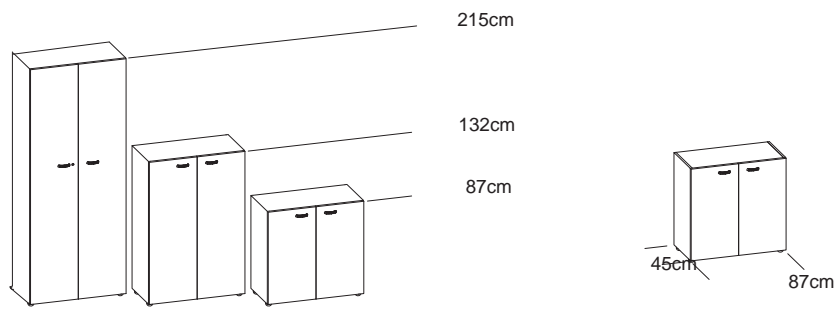

## Scocca, ante e schiene

M - Metallo

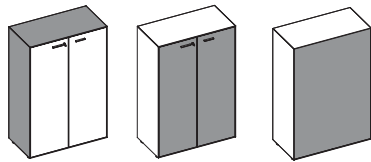

I - BIANCO RAL 9016

A - ARGENTO RAL 9006

R - GRIGIO OMBRA RAL 7022



## Ante

ME - Melaminico

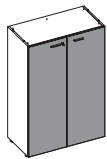

NO - NOCE CANALETTO

BA - BIANCO

GR - GRIGIO

FA - FAGGIO

OL - OLMO

WE - WENGÉ

RR - ROVERE

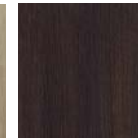
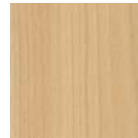
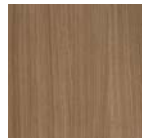

LE - Legno Impiallacciato

OG - OLMO GRIGIO

NA - NOCE AMERICANO

EB - EBANO RIGATO



CU - Cuoietto

CRS - ROSSO

CMA - MARRONE

CGA - ANTRACITE

CNE - NERO



# Finiture



\*TEMPI DI CONSEGNA: 5 SETTIMANE; FINITURE LACCATE PROPOSTE,  
TUTTE LE FINITURE DELLA SCALA RAL SONO DISPONIBILI

## Zoccoli

Abs

**I** - BIANCO RAL 9016

**A** - ARGENTO RAL 9006

**R** - GRIGIO OMBRA RAL 7022

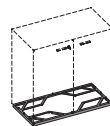

## Finitura piedini

Abs

**L** - BRILLANTATO CROMO

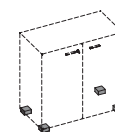

# Finiture

## Finiture armadi con anta scorrevole

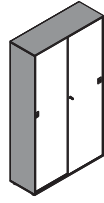

### Scocca

ME - Melaminico

BA - BIANCO

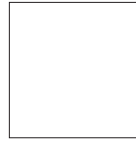

RR - ROVERE



OL - OLMO



GR - GRIGIO



NO - NOCE CANALETTO



WE - WENGÈ



### Anta scorrevole

ME - Melaminico

BA - BIANCO



RR - ROVERE



OL - OLMO



GR - GRIGIO



NO - NOCE CANALETTO

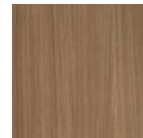

WE - WENGÈ

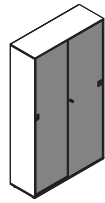

### Zoccolo

M - Metallo

A - ARGENTO RAL 9006

I - BIANCO RAL 9010

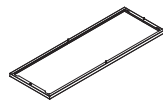
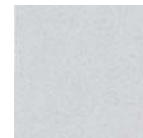



## SCHEMA DIMENSIONALE CONTENITORI IN MELAMINICO (top di finitura esclusi)

TOP DI FINITURA sp. 18-25-30mm

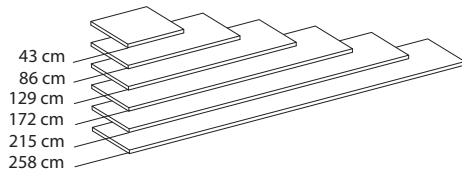

FIANCHI DI FINITURA sp. 18-25-30mm

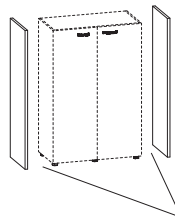

H. 86 - 131 - 214 cm

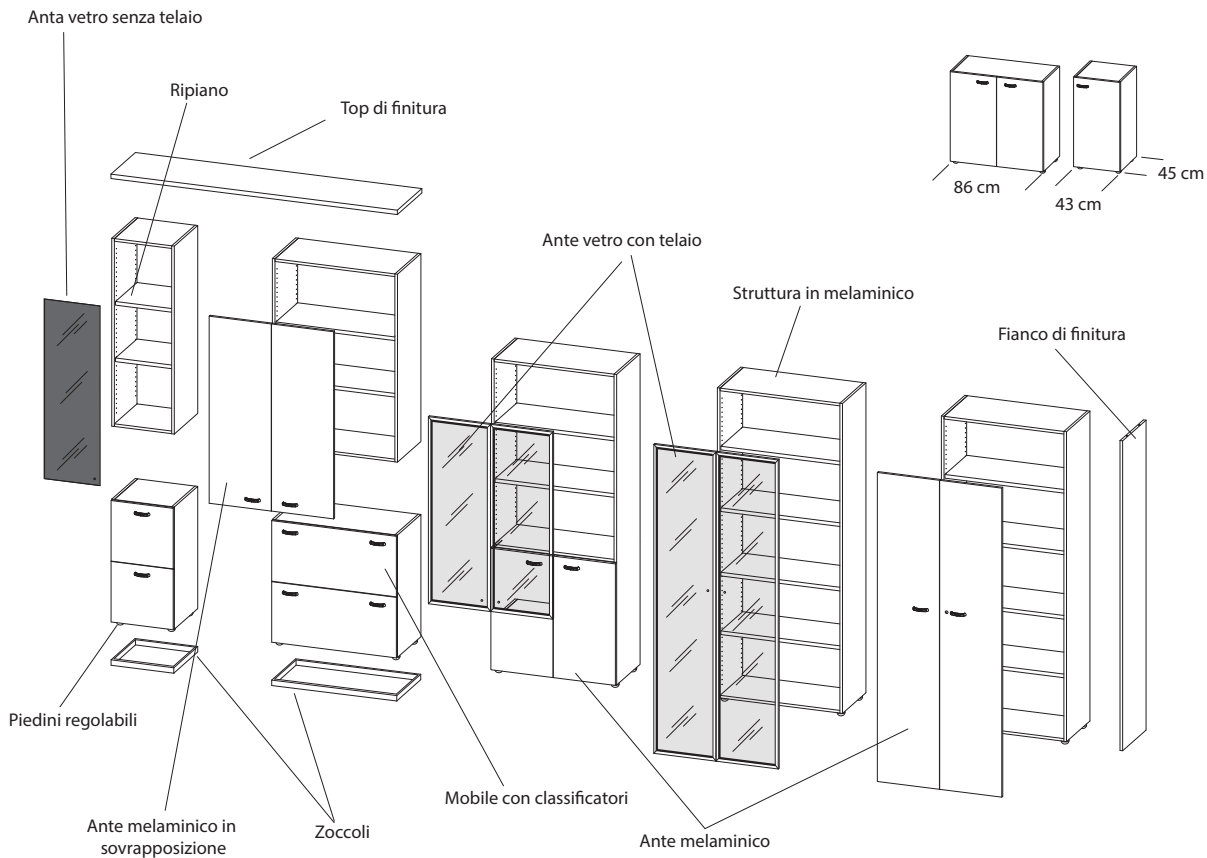
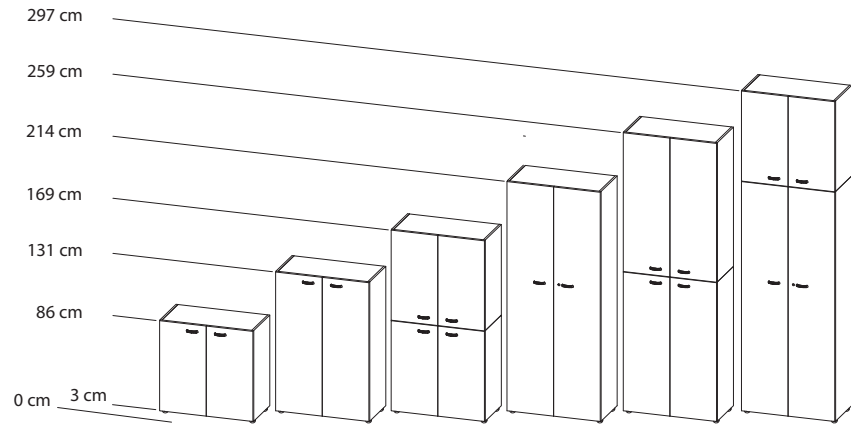

# Caratteristiche tecniche

## TOP DI FINITURA IN CUIOETTO

Top di finitura in L 43 cm

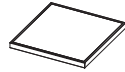

Top di finitura in L 86 cm



Top di finitura in L 172 cm

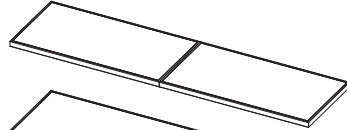

Top di finitura in L 258 cm

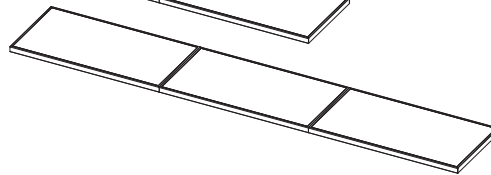

## ESEMPIO DI COMPONIBILITA' TOP DI FINITURA

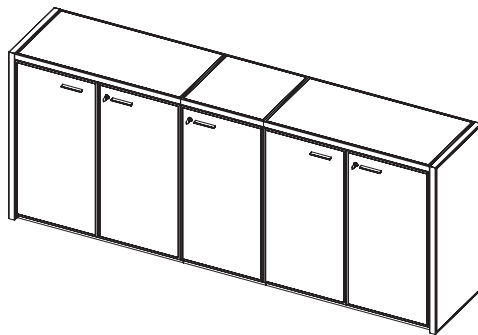

- 1) Top di finitura L. 86 cm
- 2) Top di finitura L. 43 cm
- 3) Armadio base con ante L. 86 cm
- 4) Armadio base con ante L. 43 cm
- 5) Fianchi di finitura H. 86 cm

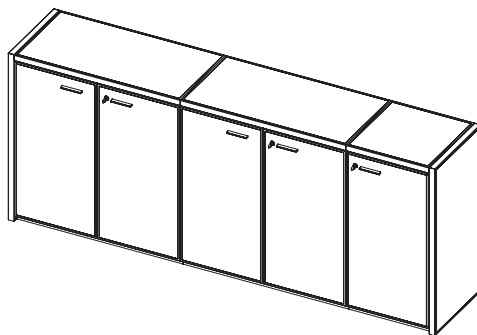
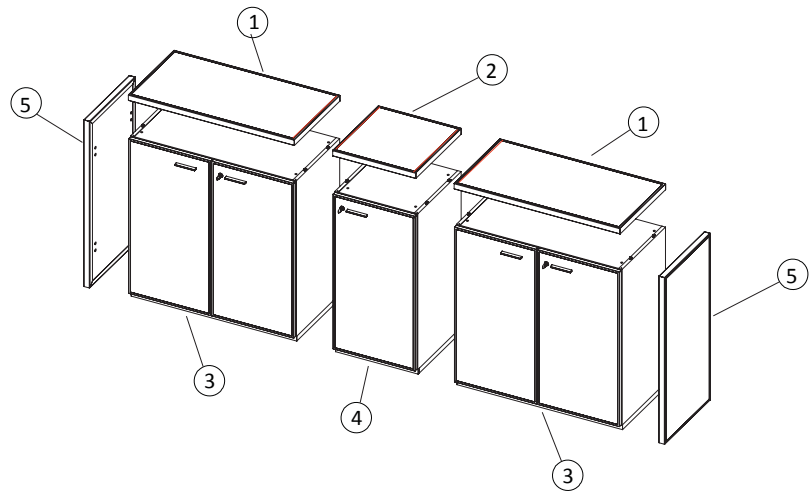

- 1) Top di finitura L. 172 cm
- 2) Top di finitura L. 43 cm
- 3) Armadio base con ante L. 86 cm
- 4) Armadio base con ante L. 43 cm
- 5) Fianchi di finitura H. 86 cm

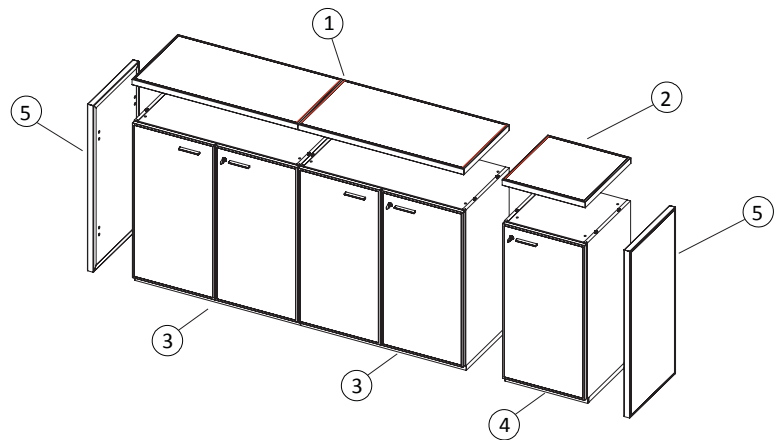

**Per motivi tecnici sono previste cuciture e giunzioni ogni 86 cm nei top di finitura in cuoietto da L.172 cm e 258 cm.  
Per realizzare composizioni di armadi in L. 129 e 215 cm è previsto l'accostamento di top da 86/172 cm con top in 43 cm.**

## LISTINO ARMADI FUORI MISURA

### STRUTTURE IN MELAMINICO

#### RIDUZIONE STRUTTURA ARMADIO IN LARGHEZZA

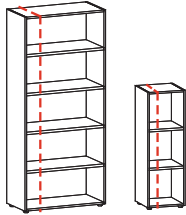

Riduzione minima 36mm  
Maggiorazione + 50% su prezzo di listino

### ANTE IN MELAMINICO, LACCATO E CUOIETTO

#### RIDUZIONE ANTA IN LARGHEZZA

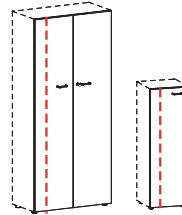

Riduzione minima 40mm per anta  
Maggiorazione + 35% per anta su prezzo di listino

#### RIDUZIONE STRUTTURA ARMADIO IN ALTEZZA

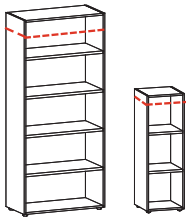

Riduzione minima 15mm  
Maggiorazione + 35% su prezzo di listino

#### RIDUZIONE ANTA IN ALTEZZA

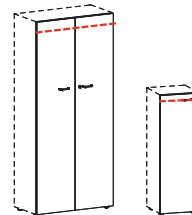

Data la presenza della foratura per cerniera,  
riduzione minima da 15 a 47mm o superiore a  
125mm.  
Maggiorazione + 35% per anta su prezzo di listino

#### RIDUZIONE STRUTTURA ARMADIO IN PROFONDITA'

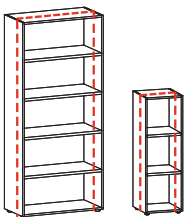

Riduzione minima 15mm  
Maggiorazione + 60% su prezzo di listino